

Centre No.						Paper Reference						Surname <i>Correction</i>	Initial(s)	
Candidate No.						1	3	8	0	/	2	F	Signature <i>M. Semar</i>	

Paper Reference(s)

**1380/2F**

**Edexcel GCSE**

**Mathematics (Linear) – 1380**

**Paper 2 (Calculator)**

**Foundation Tier**

**Monday 14 November 2011 – Morning**

**Time: 1 hour 30 minutes**

Examiner's use only

--	--	--

Team Leader's use only

--	--	--



**Materials required for examination**

Ruler graduated in centimetres and millimetres, protractor, compasses, pen, HB pencil, eraser, calculator. Tracing paper may be used.

**Items included with question papers**

Nil

**Instructions to Candidates**

In the boxes above, write your centre number, candidate number, your surname, initials and signature.

Check that you have the correct question paper.

Answer ALL the questions. Write your answers in the spaces provided in this question paper.

**You must NOT write on the formulae page.**

**Anything you write on the formulae page will gain NO credit.**

If you need more space to complete your answer to any question, use additional answer sheets.

**Information for Candidates**

The marks for individual questions and the parts of questions are shown in round brackets: e.g. (2).

There are 29 questions in this question paper. The total mark for this paper is 100.

There are 24 pages in this question paper. Any blank pages are indicated.

**Calculators may be used.**

If your calculator does not have a  $\pi$  button, take the value of  $\pi$  to be 3.142 unless the question instructs otherwise.

**Advice to Candidates**

Show all stages in any calculations.

Work steadily through the paper. Do not spend too long on one question.

If you cannot answer a question, leave it and attempt the next one.

Return at the end to those you have left out.

This publication may be reproduced only in accordance with Edexcel Limited copyright policy.  
©2011 Edexcel Limited.

Printer's Log No.

**P40087A**

W850/R1380E/57570 6/6/6



*Turn over*

**edexcel**   
advancing learning, changing lives

## GCSE Mathematics (Linear) 1380

Formulae: Foundation Tier

**You must not write on this formulae page.**  
**Anything you write on this formulae page will gain NO credit.**

$$\text{Area of trapezium} = \frac{1}{2}(a + b)h$$

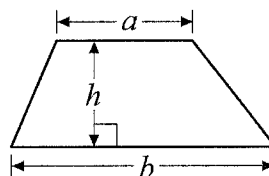

$$\text{Volume of prism} = \text{area of cross section} \times \text{length}$$

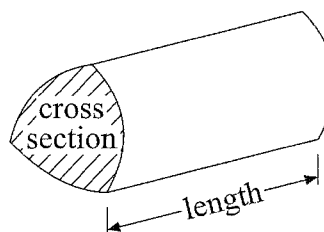

Answer ALL TWENTY NINE questions.

Write your answers in the spaces provided.

You must write down all stages in your working.

1.

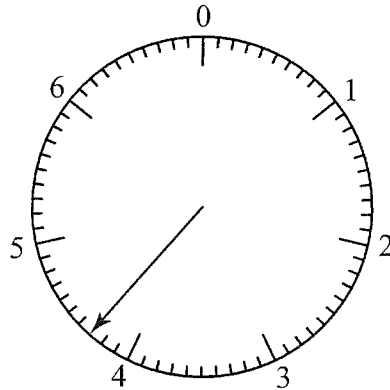

(a) Write down the number shown by the arrow.

4.3  
.....  
(1)

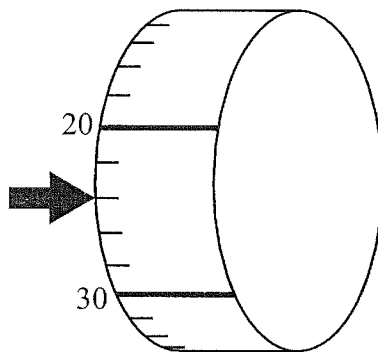

(b) Write down the number shown by the arrow.

24  
.....  
(1)

(Total 2 marks)

Q1



2. A television programme started at 17 55  
The programme was 1 hour 20 minutes long.

(i) At what time did the programme end?

$$17.55 + 1 \text{ hr } 20 \text{ mn}$$

19 15

Mumtaz started to watch this programme at 18 34

(ii) How many minutes of the programme did Mumtaz miss?

$$34 + 5 = 39 \text{ mn}$$

39

..... minutes

(Total 3 marks)

Q2

3. (a) Write these numbers in order of size.  
Start with the smallest number.

13.1      0.89      1.2      7.01

0.89    1.2    7.01    13.1

(1)

(b) Write these numbers in order of size.  
Start with the smallest number.

2      -8      6      0      -3

-8    -3    0    2    6

(1)

$$15 - 4 \times 2 + 1 = 3$$

(c) Put brackets in the calculation above to make it correct.

$$15 - 4 \times (2 + 1) = 3$$

(1)

(Total 3 marks)

Q3



4.

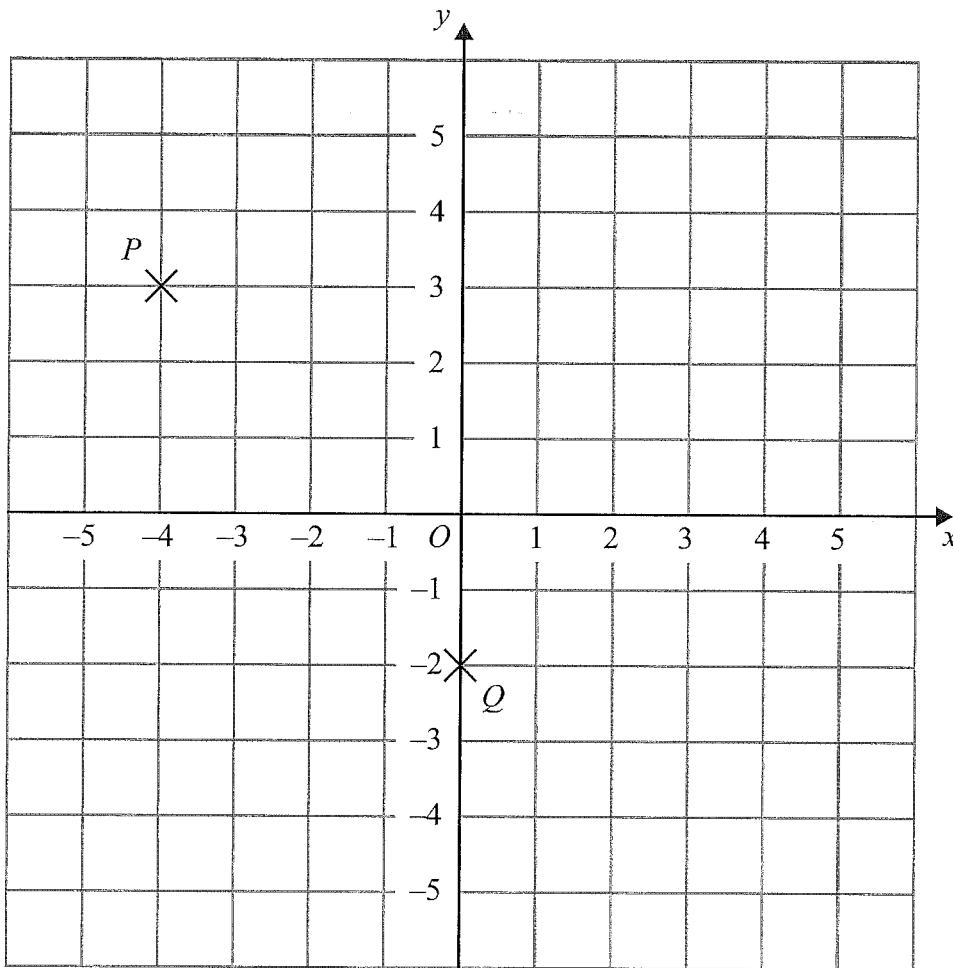

(a) (i) Write down the coordinates of the point P.

(-4, 3)

(ii) Write down the coordinates of the point Q.

(0, -2)  
(2)

(b) Find the coordinates of the midpoint of PQ.

$$\left( \frac{-4+0}{2}, \frac{3-2}{2} \right)$$

$$\left( -2, \frac{1}{2} \right)$$

(-2, 1/2)  
(2)

(Total 4 marks)

Q4



5. Some children were asked to name their favourite flavour of ice cream. The pie chart and table show some information about their answers.

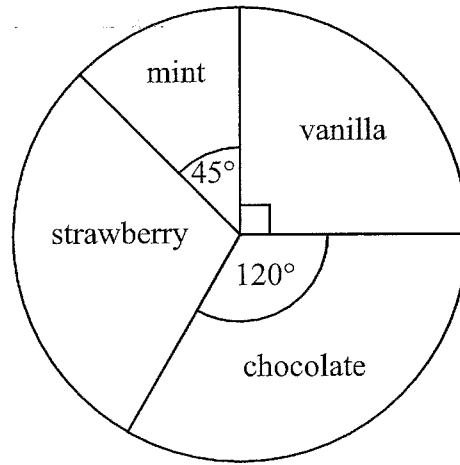

Use the pie chart to complete the table.

Flavour	Number of children	Angle of sector
vanilla	12	90°
mint	6	45°
strawberry	14	105°
chocolate	16	120°

(Total 3 marks)

Q5

children	Angle
12	90
4	30
16	120



6. The shaded shape is drawn on a grid of centimetre squares.

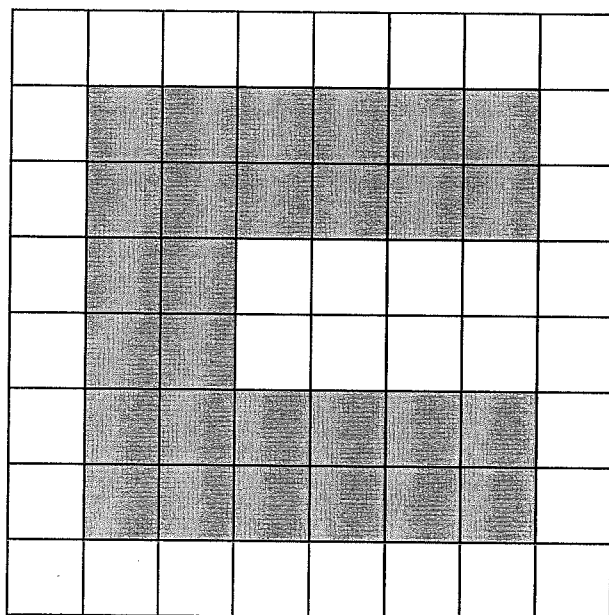

Find the area of the shaded shape.

$$6 \times 6 - 4 \times 2$$

$$28 \text{ cm}^2$$

Q6

(Total 2 marks)



7.

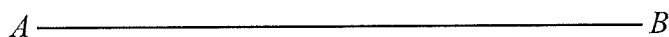

(a) Measure the length of the line  $AB$ .

..... 8 ..... cm  
(1)

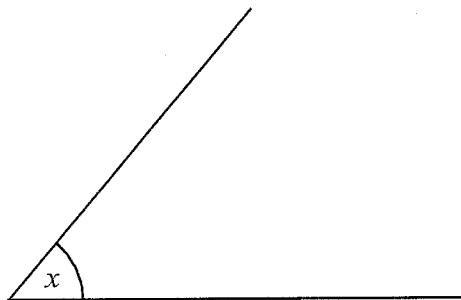

(b) Measure the size of the angle marked  $x$ .

Accept  $48^\circ - 52^\circ$

..... 50 .....  
(1)

(c) In the space below, draw an angle of  $130^\circ$  at  $P$ .

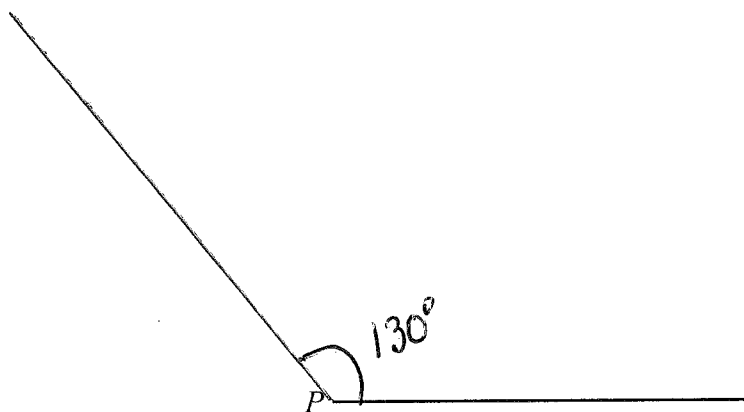

(1)

Q7

(Total 3 marks)





8. The table shows which countries the World Snooker champions came from for the years 1992 to 2009

Year	Country
1992	Scotland
1993	Scotland
1994	Scotland
1995	Scotland
1996	Scotland
1997	Ireland

Year	Country
1998	Scotland
1999	Scotland
2000	Wales
2001	England
2002	England
2003	Wales

Year	Country
2004	England
2005	England
2006	Scotland
2007	Scotland
2008	England
2009	Scotland

(a) Complete the tally chart to show this information.

Country	Tally	Frequency
England		5
Ireland		1
Scotland		10
Wales		2

(2)

(b) On the grid, draw a bar chart to show this information.

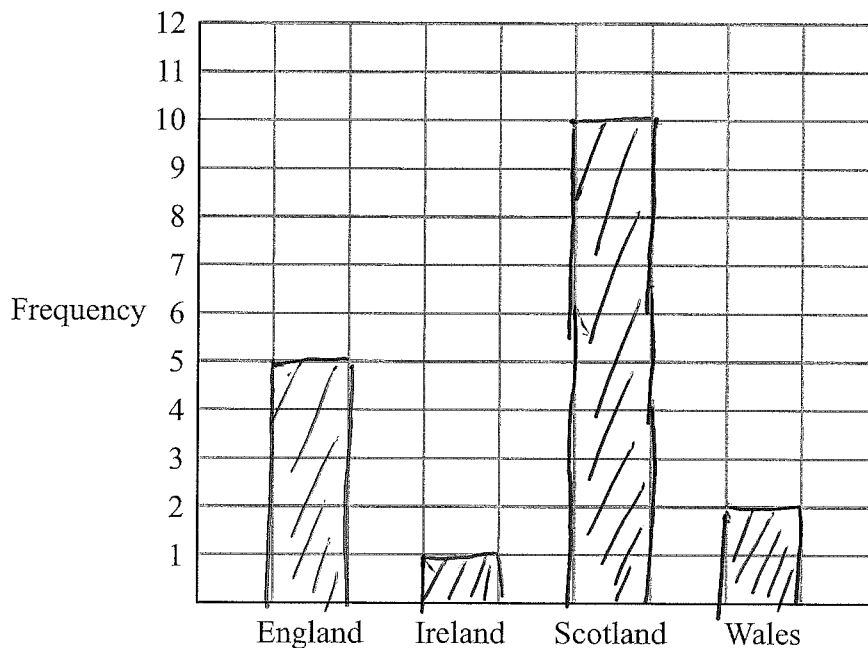

(2)

(Total 4 marks)

Q8



9. (a) Write down the fraction of the shape that is shaded.

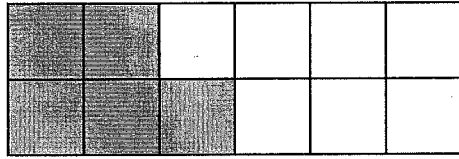

$$\frac{5}{12}$$

(1)

(b) Change  $\frac{3}{8}$  to a decimal.

$$\frac{1}{8} = 0.125 \Rightarrow \frac{3}{8} = 0.125 \times 3$$

$$0.375$$

(1)

Here are some fractions.

$$\frac{3}{8} \quad \frac{5}{12} \quad \frac{7}{24} \quad \frac{1}{6}$$

(c) Which of these fractions is nearest in size to  $\frac{1}{4}$ ?

You must show how you got your answer.

$$\frac{3}{8} = 37.5\% \quad \frac{7}{24} \approx 29.1\% \rightarrow \text{close to } 25\% = \frac{1}{4}$$

$$\frac{5}{12} = 41.6\% \quad \frac{1}{6} \approx 16.6\%$$

$$\frac{7}{24}$$

(2)

(Total 4 marks)

Q9

10. (a) Simplify  $p + p + p + p + p + p$

$$6p$$

(1)

(b) Simplify  $5m - m$

$$4m$$

(1)

(Total 2 marks)

Q10



11. The exchange rate to change pounds (£) into US dollars (\$) is £1 = \$1.50

(a) Use this exchange rate to complete the table below.

<b>Pounds (£)</b>	0	1	2	5	10	20	50	100
<b>US dollars (\$)</b>	0	1.50	3	7.50	15	30	75	150

(2)

(b) On the grid, draw a conversion graph for converting between pounds and US dollars.

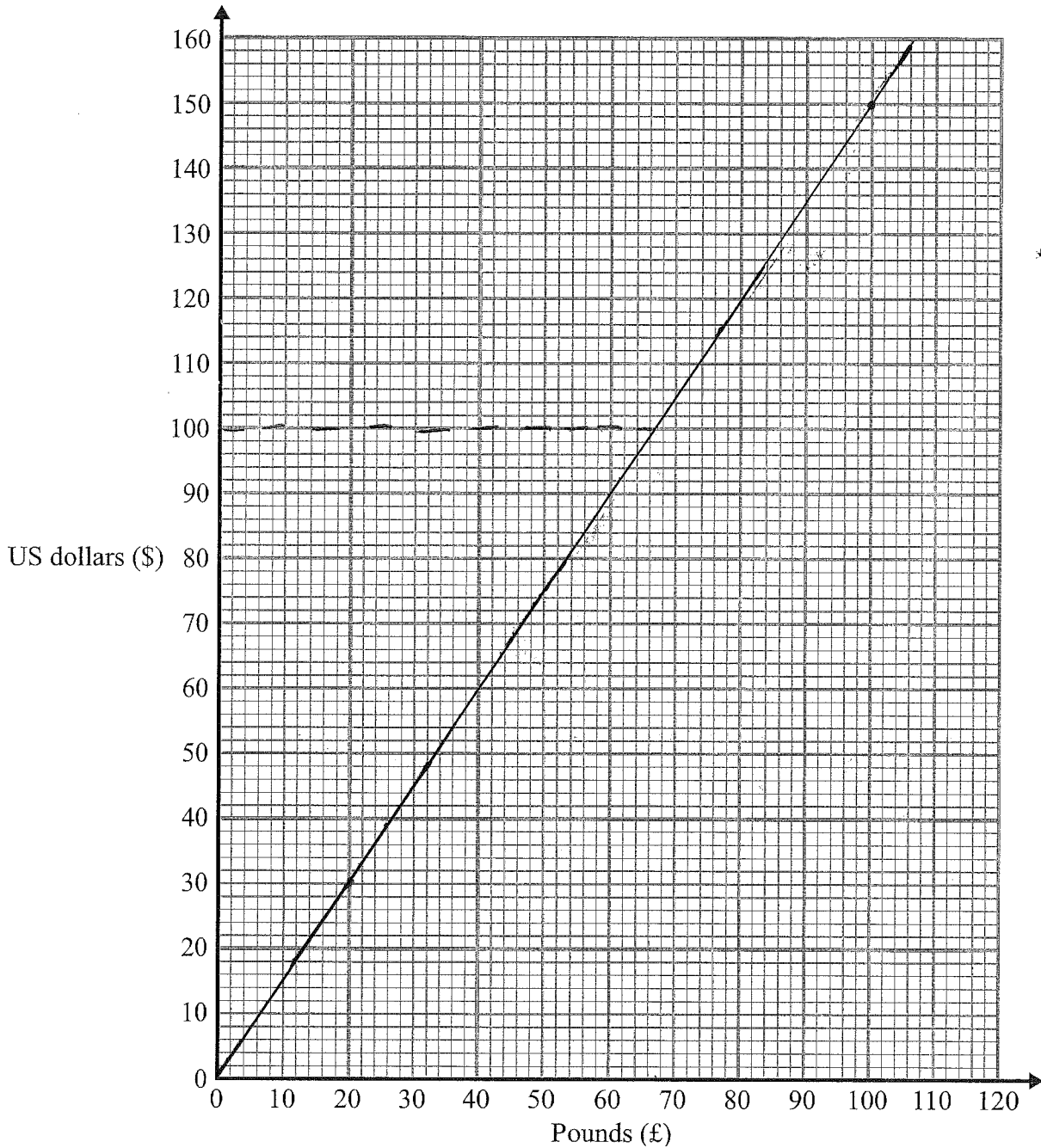

(2)

(c) Change \$100 into pounds (£).

Accept 65-68

£ ..... 67 .....

(2)

(Total 6 marks)

Q11



12. The lengths, in minutes, of 10 football matches were

95 91 98 93 93 90 92 99 97 93

(a) Write down the mode.

$$\begin{array}{r} 93 \\ \hline \end{array} \quad (1)$$

(b) Find the range.

$$99 - 90$$

$$\begin{array}{r} 09 \\ \hline \end{array} \quad (2)$$

(c) Work out the mean.

$$\frac{95 + 91 + 98 + 93 + 90 + 92 + 99 + 97 + 93}{10} = 94.1$$

$$\begin{array}{r} 94.1 \\ \hline \end{array} \quad (2)$$

(Total 5 marks)

Q12

13. (a) Solve  $4x = 20$

$$\frac{4x}{4} = \frac{20}{4}$$

$$x = 5$$

$$\begin{array}{r} 5 \\ \hline \end{array} \quad (1)$$

(b) Solve  $\frac{y}{3} = 9$

$$3 \times \frac{y}{3} = 9 \times 3$$

$$y = 27$$

$$\begin{array}{r} 27 \\ \hline \end{array} \quad (1)$$

(Total 2 marks)

Q13



14. The diagram shows a solid prism.

Diagram NOT accurately drawn

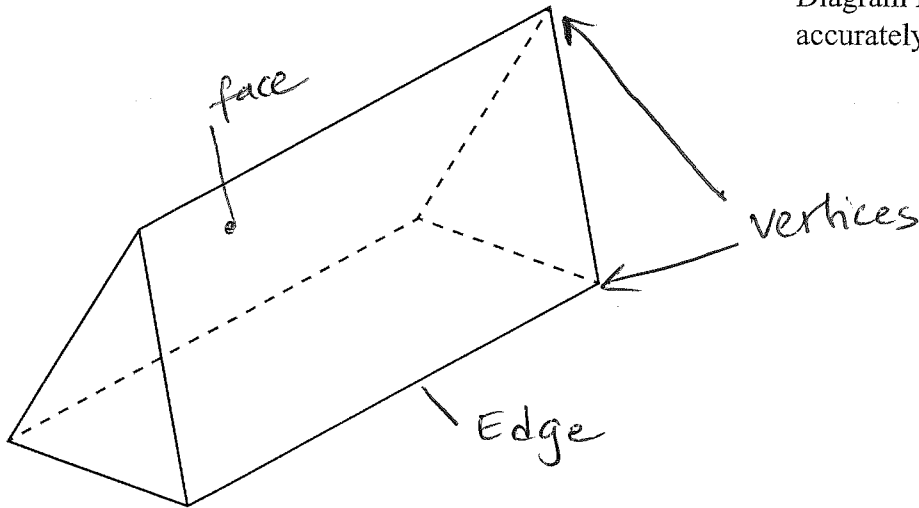

Write down

(i) the number of vertices ..... 6

(ii) the number of faces ..... 5

(iii) the number of edges ..... 9

Q14

(Total 3 marks)

15. Ron bought 3 kg of potatoes and 2 kg of carrots.  
The total cost was £5.08

Potatoes cost £1.24 per kg.  
Work out the cost of 1 kg of carrots.

$$3 \text{ kg of potatoes} = 3 \times 1.24 = \text{£} 3.72$$

$$2 \text{ kg of carrots} = 5.08 - 3.72 = \text{£} 1.36$$

$$1 \text{ kg of carrots} = 1.36 \div 2 = \text{£} 0.68$$

..... 68 pence

Q15

(Total 3 marks)



16. The two-way table gives some information about the types of holiday 80 people had.

	Caravan	Camping	Hotel	Total
Adult	15	6	28	49
Child	8	19	4	31
Total	23	25	32	80

Complete the two-way table.

Q16

(Total 3 marks)

17.

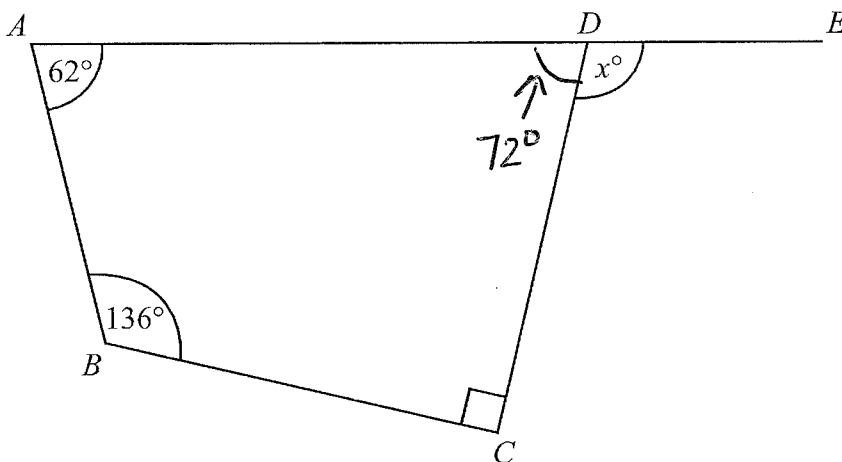

Diagram NOT accurately drawn

$ABCD$  is a quadrilateral.  
 $ADE$  is a straight line.

Work out the value of  $x$ .

$$\angle ADC = 360 - (62 + 136 + 90)$$

$$\angle ADC = 360 - 288 = 72^\circ$$

$$x + 72 = 180$$

$$x = 108$$

$$x = \dots\dots\dots 108^\circ \dots\dots\dots$$

Q17

(Total 3 marks)



18. On the grid, show how this shape tessellates.

You need to draw at least 6 shapes.

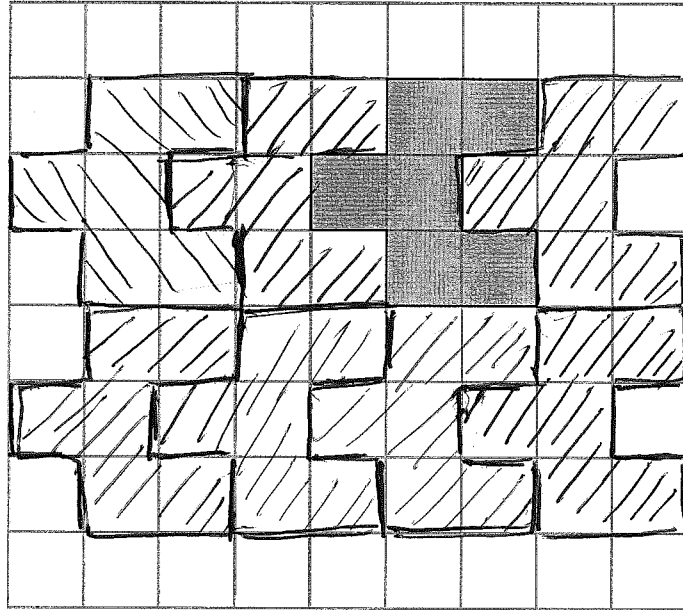

Q18

(Total 2 marks)

19. (a) Use your calculator to work out

$$\frac{\sqrt{21.5}}{5.8 - 2.36}$$

Write down all the figures on your calculator display.



1.3479

(2)

(b) Write down your answer to part (a) correct to 2 decimal places.

1.35

(1)

Q19

(Total 3 marks)



20. Ishmal invested £3500 for 3 years at 2.5% per annum **simple interest**.

Work out the total amount of interest Ishmal earned.

In One year, Interest =  $\frac{3500}{100} \times 2.5$

In 3 years  $\frac{3500}{100} \times 2.5 \times 3$

£ 262.50

(Total 3 marks)

Q20

21. (a) (i) Find all the factors of 30

1, 2, 3, 5, 6, 10, 15, 30

(ii) Find the highest common factor (HCF) of 24 and 30

1, 2, 3, 4, 6, 8, 12, 24  
 1, 2, 3, 5, 6, 10, 15, 30

6

(3)

(b) Find the lowest common multiple (LCM) of 4, 5 and 6

$4 = 2 \times 2 = 2^2$   
 $5 = 1 \times 5 = 5 \times 1$   
 $6 = 2 \times 3 = 2 \times 3$

$LCM = 2^2 \times 5 \times 3$

60

(2)

(Total 5 marks)

Q21





22.

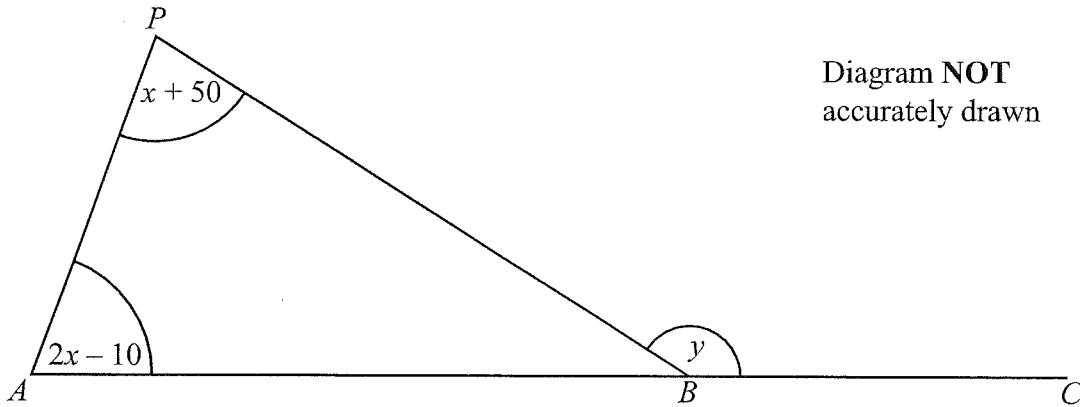

All angles are measured in degrees.

$ABC$  is a straight line.

Angle  $APB = x + 50$

Angle  $PAB = 2x - 10$

Angle  $PBC = y$

- (a) Show that  $y = 3x + 40$   
Give reasons for each stage of your working.

$$y = x + 50 + 2x - 10$$

$$y = 3x + 40 \quad \text{Exterior angle in a triangle (y) equals the sum of interior opposite angles} \quad (3)$$

- (b) Given that  $y = 145$ ,

- (i) work out the value of  $x$ ,

$$3x + 40 = 145$$

$$3x = 145 - 40$$

$$3x = 105 \quad x = \dots\dots\dots 35$$

- (ii) work out the size of the largest angle in triangle  $ABP$ .

$$x + 50 = 35 + 50 = 85^\circ$$

$$2x - 10 = 2 \times 35 - 10 = 70^\circ$$

$$\angle PBA = 180 - (85 + 70) = 25^\circ \quad \dots\dots\dots 85^\circ \quad (4)$$

(Total 7 marks)

Q22



Leave  
blank

23. Work out the value of  $\frac{6^5 \times 6^2}{6^4} = \frac{6^{5+2}}{6^4} = \frac{6^7}{6^4}$

Give your answer as a power of 6

$$= 6^{7-4} = 6^3$$

$$6^3$$

Q23

(Total 2 marks)

24.  $-2 \leq n < 5$   
 $n$  is an integer.

(a) Write down all the possible values of  $n$ .

$$-2, -1, 0, 1, 2, 3, 4$$

(2)

(b) Expand and simplify  $(x+5)(x-3)$

$$x^2 - 3x + 5x - 15$$

$$x^2 + 2x - 15$$

(2)

Q24

(Total 4 marks)



25. Mandy needs a permit to fish in her local river.  
 Last year, Mandy paid £140 for a permit.  
 This year the cost of the permit increased by 12%.

(a) Work out the cost of the permit for this year.

$$100\% + 12\% = 112\%$$

$$112\% \text{ of } 140 = \frac{112}{100} \times 140 = 1.12 \times 140$$

OR:  $12\% \text{ of } 140 = \frac{12}{100} \times 140 = 16.80$

New price =  $140 + 16.80$       £ 156.80 (3)

The largest fish Mandy caught last year weighed 11 kg correct to the nearest kg.

(b) (i) Write down the smallest possible weight of this fish.

10.5 kg

(ii) Write down the largest possible weight of this fish.

11.5 kg (2)

(Total 5 marks)

Q25

26. Melissa is 13 years old.  
 Becky is 12 years old.  
 Daniel is 10 years old.

Melissa, Becky and Daniel share £28 in the ratio of their ages.  
 Becky gives a third of her share to her mother.

How much should Becky now have?

Melissa    Becky    Daniel  
 13            12            10

$$13 + 12 + 10 = 35 \text{ shares}$$

$$\text{One share} = 2800 \div 35 = 80 \text{ pence}$$

Becky's shares:  $12 \times 80 = 960 \text{ pence}$       £ 6.40

Becky has  $\frac{2}{3} \times 960 = 640 \text{ pence}$

(Total 4 marks)

Q26



27. Gary wants to find out how much time teenagers spend listening to music.

He uses this question on a questionnaire.

How many hours do you spend listening to music?

<input type="checkbox"/>	<input type="checkbox"/>	<input type="checkbox"/>	<input type="checkbox"/>
1 to 5	5 to 10	10 to 20	over 20

(a) Write down **two** things wrong with this question.

1 Overlapping boxes -

2 No time period (per day / per week) - eh

(2)

(b) Design a better question for Gary's questionnaire to find out how much time teenagers spend listening to music.

How many hours a day do you listen to music?

0-3 hrs

over 3-5 hrs

over 5 hrs

(2)

Q27

(Total 4 marks)



28. The diagram shows a right-angled triangle.

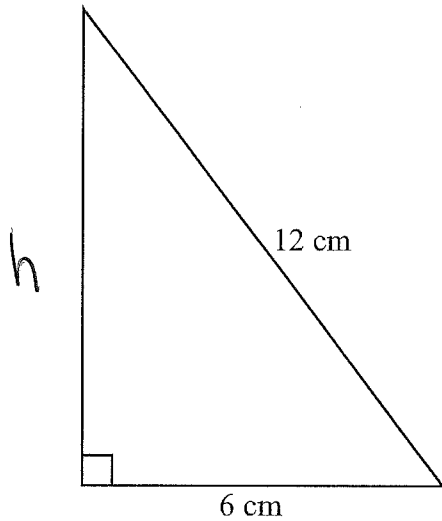
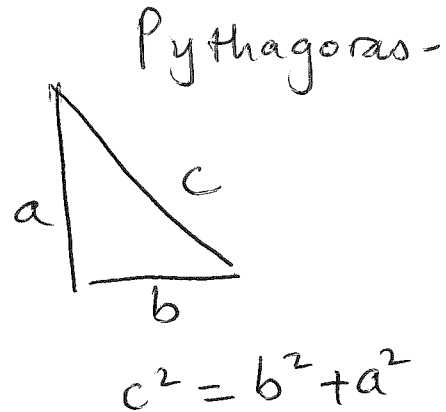

Diagram NOT accurately drawn



Calculate the area of the right-angled triangle.  
Give your answer correct to 2 decimal places.

$$h^2 + 6^2 = 12^2 \text{ (Pythagoras)}$$

$$h^2 = 144 - 36$$

$$h = \sqrt{144 - 36} = 10.392$$

$$\text{Area} = \frac{6 \times 10.392}{2}$$

..... 31.18 cm<sup>2</sup>

(Total 4 marks)

Q28



29. The diagram shows a CD.  
The CD is a circle of radius 6 cm.

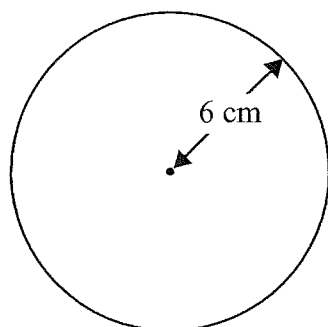
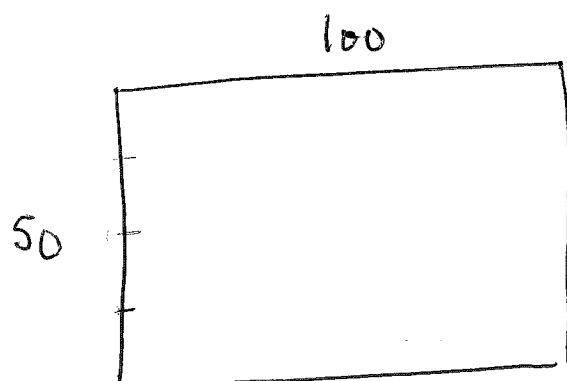

Diagram NOT accurately drawn

CDs of this size are cut from rectangular sheets of plastic.  
Each sheet is 1 metre long and 50 cm wide.

Work out the greatest number of CDs that can be cut from one rectangular sheet.



$$50 \div 12 = 4$$

$$100 \div 12 = 8$$

$$(100 \div 12) \times (50 \div 12) = 32$$

$$8 \times 4 = 32$$

32

(Total 2 marks)

Q29

TOTAL FOR PAPER: 100 MARKS

END



**BLANK PAGE**



BLANK PAGE

Optician  
0203313 7518

