

Write your name here

Surname

correction

Other names

M. Senar

Centre Number

--	--	--	--	--

Candidate Number

--	--	--	--	--

**Edexcel GCSE**

# Mathematics A

## Paper 2 (Calculator)

✓ **Higher Tier**

Monday 4 March 2013 – Morning

**Time: 1 hour 45 minutes**

Paper Reference

**1MA0/2H**

**You must have:** Ruler graduated in centimetres and millimetres, protractor, pair of compasses, pen, HB pencil, eraser, calculator. Tracing paper may be used.

Total Marks

### Instructions

- Use **black** ink or ball-point pen.
- **Fill in the boxes** at the top of this page with your name, centre number and candidate number.
- Answer **all** questions.
- Answer the questions in the spaces provided – *there may be more space than you need.*
- **Calculators may be used.**
- If your calculator does not have a  $\pi$  button, take the value of  $\pi$  to be 3.142 unless the question instructs otherwise.



### Information

- The total mark for this paper is 100
- The marks for **each** question are shown in brackets – *use this as a guide as to how much time to spend on each question.*
- Questions labelled with an **asterisk** (\*) are ones where the quality of your written communication will be assessed.

### Advice

- Read each question carefully before you start to answer it.
- Keep an eye on the time.
- Try to answer every question.
- Check your answers if you have time at the end.

Turn over ▶

P42059A

©2013 Pearson Education Ltd.

6/7/14/



**PEARSON**

# GCSE Mathematics 1MA0

## Formulae: Higher Tier

**You must not write on this formulae page.  
Anything you write on this formulae page will gain NO credit.**

**Volume of prism** = area of cross section  $\times$  length

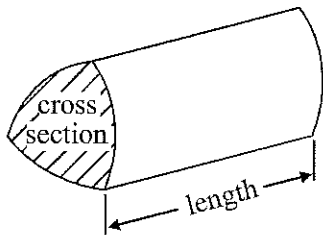

**Area of trapezium** =  $\frac{1}{2} (a + b)h$

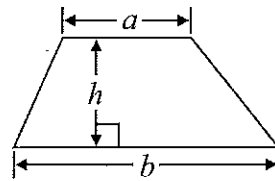

**Volume of sphere** =  $\frac{4}{3} \pi r^3$

**Surface area of sphere** =  $4\pi r^2$

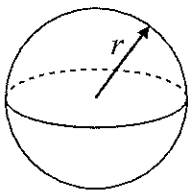

**Volume of cone** =  $\frac{1}{3} \pi r^2 h$

**Curved surface area of cone** =  $\pi r l$

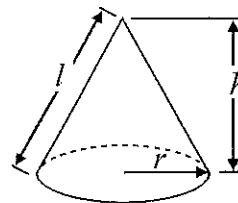

**In any triangle ABC**

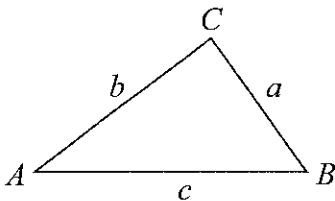

**The Quadratic Equation**

The solutions of  $ax^2 + bx + c = 0$   
where  $a \neq 0$ , are given by

$$x = \frac{-b \pm \sqrt{b^2 - 4ac}}{2a}$$

**Sine Rule**  $\frac{a}{\sin A} = \frac{b}{\sin B} = \frac{c}{\sin C}$

**Cosine Rule**  $a^2 = b^2 + c^2 - 2bc \cos A$

**Area of triangle** =  $\frac{1}{2} ab \sin C$



Answer ALL questions.

Write your answers in the spaces provided.

You must write down all stages in your working.

1 Here are the ages, in years, of 15 students.

~~19~~ ~~18~~ ~~20~~ ~~25~~ ~~37~~  
~~33~~ ~~21~~ ~~17~~ ~~29~~ ~~20~~  
42 18 23 37 22

Show this information in an ordered stem and leaf diagram.

17 18 18 19 20  
20 21 22 23 25  
29 33 37 37 42

1	7	8	8	9			
2	0	0	1	2	3	5	9
3	3	7	7				
4	2						

Key: 3|7 = 37yrs

(Total for Question 1 is 3 marks)



\*2 225 grams of flour are needed to make 9 cakes.

Marian wants to make 20 of these cakes.  
She has 475 grams of flour.

Does Marian have enough flour to make 20 cakes?  
You must show all your working.

9 cakes need 225 gr

1 cake needs  $225 \div 9$  gr

20 cakes need  $\frac{225}{9} \times 20 = 500$ g flour

Marian doesnot have enough flour -

(Total for Question 2 is 3 marks)



- 3 Simon went for a cycle ride.  
He left home at 2 pm.

The travel graph represents part of Simon's cycle ride.

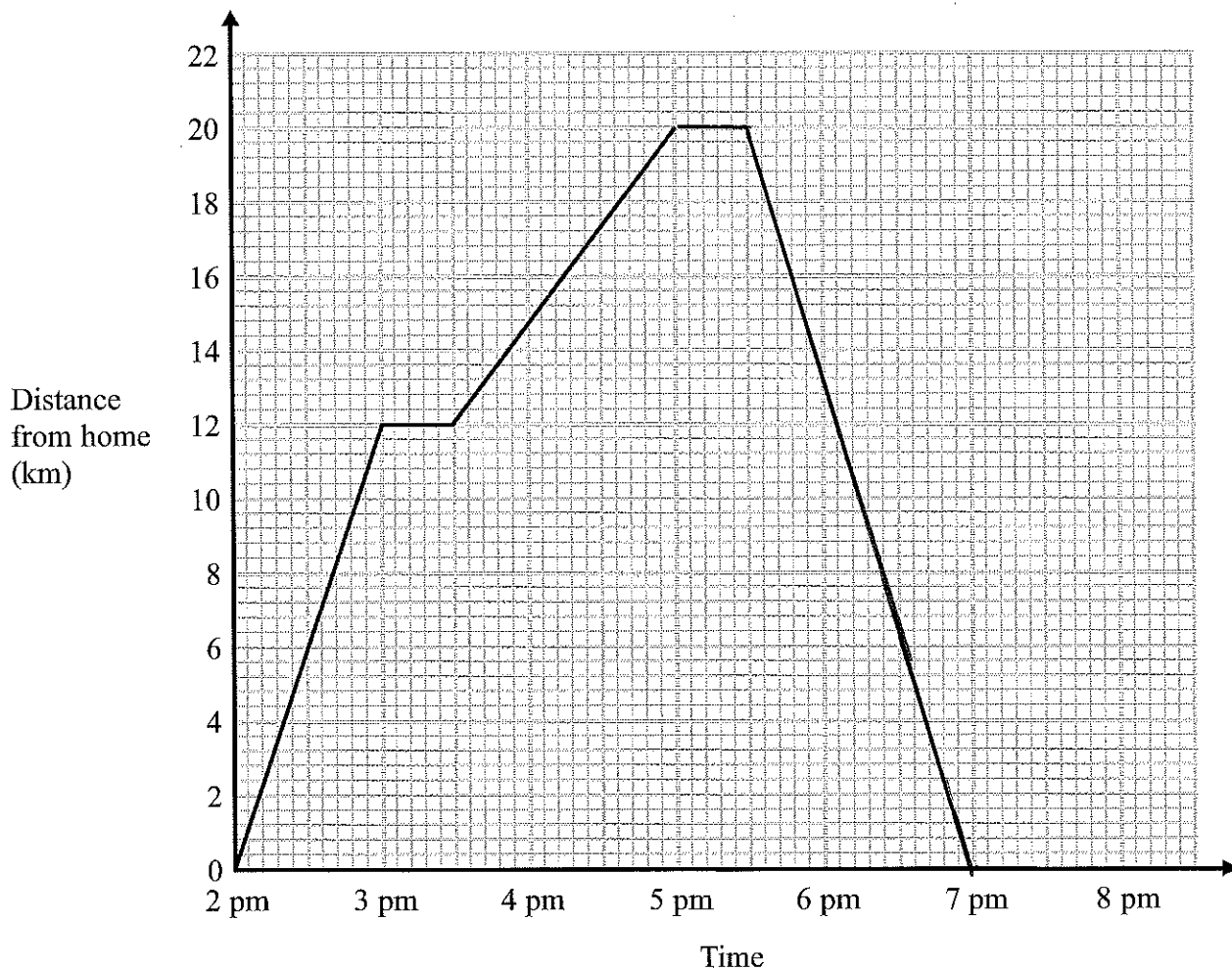

At 3 pm Simon stopped for a rest.

- (a) How many minutes did he rest?

..... 30 ..... minutes  
(1)

- (b) How far was Simon from home at 5 pm?

..... 20 ..... km  
(1)

At 5 pm Simon stopped for 30 minutes.  
Then he cycled home at a steady speed.  
It took him 1 hour 30 minutes to get home.

- (c) Complete the travel graph.

(2)

(Total for Question 3 is 4 marks)



- 4 Here is a four sided spinner.  
The spinner is biased.

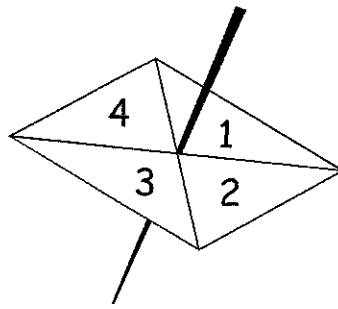

The table shows the probabilities that the spinner will land on 1 or on 3

<b>Number</b>	1	2	3	4
<b>Probability</b>	0.2		0.1	

The probability that the spinner will land on 2 is the same as the probability that the spinner will land on 4

- (a) Work out the probability that the spinner will land on 4

$$\begin{aligned}
 0.2 + x + 0.1 + x &= 1 \\
 2x + 0.3 &= 1 \\
 2x &= 0.7 \\
 x &= 0.35
 \end{aligned}$$

$$\begin{array}{r}
 0.35 \\
 \hline
 (3)
 \end{array}$$

Shunya is going to spin the spinner 200 times.

- (b) Work out an estimate for the number of times the spinner will land on 3

$$0.1 \times 200 = 20$$

$$\begin{array}{r}
 20 \\
 \hline
 (2)
 \end{array}$$

(Total for Question 4 is 5 marks)



5

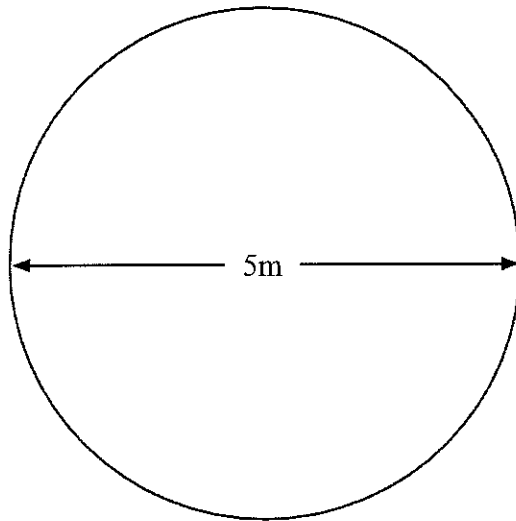

Diagram NOT  
accurately drawn

Jon has a flower garden in the shape of a circle.  
The diameter of the garden is 5 metres.

Jon wants to put fencing around the edge of the garden.  
The fencing costs £1.80 per metre.

Work out the total cost of the fencing.

$$\begin{aligned} \text{Circumference of the garden} &= \pi \times d \\ &= 5\pi \text{ m} \end{aligned}$$

$$\text{Cost of fencing} = 1.80 \times 5 \times \pi$$

£ 28.27

(Total for Question 5 is 3 marks)



6 Mr Watkins needs to buy some oil for his central heating.

Mr Watkins can put up to 1500 litres of oil in his oil tank.

There are already 850 litres of oil in the tank.

Mr Watkins is going to fill the tank with oil.

The price of oil is 67.2p per litre.

Mr Watkins gets 5% off the price of the oil.

How much does Mr Watkins pay for the oil he needs to buy?

$$\begin{aligned}\text{Oil he needs to buy} &= 1500 - 850 \\ &= 650 \text{ l}\end{aligned}$$

$$\begin{aligned}\text{Cost of oil} &= 650 \times 67.2 \\ &= 43680 \text{ p} = \text{£}436.80\end{aligned}$$

5% reduction (off the price) means that Mr Watkins only pays 95% of the cost of oil:

$$\begin{aligned}95\% \times 436.80 &= 0.95 \times 436.80 \\ &= \text{£}414.96\end{aligned}$$

Method 2:

$$\begin{aligned}5\% \text{ of } 436.80 &= 0.05 \times 436.80 \\ &= \text{£}21.84 \text{ (Reduction)}\end{aligned}$$

$$\begin{aligned}\text{Cost of oil} &= 436.80 - 21.84 \\ &= \text{£}414.96\end{aligned}$$

£ 414.96

(Total for Question 6 is 5 marks)





7 Peter goes for a walk.  
He walks 15 miles in 6 hours.

- (a) Work out Peter's average speed.  
Give your answer in miles per hour.

$$S = \frac{D}{T}$$

$$S = \frac{15}{6} = \frac{5}{2} = 2.5$$

$$\frac{2.5}{(2)} \text{ mph}$$

5 miles = 8 km.

Sunita says that Peter walked more than 20 km.

- \*(b) Is Sunita right?  
You must show all your working.

$$5 \text{ miles} = 8 \text{ km}$$

$$15 \text{ miles} = 8 \times 3 \text{ km} \\ = 24 \text{ km}$$

$$15 \text{ miles} = 24 \text{ km}$$

Sunita is right

(2)

(Total for Question 7 is 4 marks)



8 The equation

$$x^3 - 3x = 15$$

has a solution between 2 and 3

Use a trial and improvement method to find this solution.

Give your answer correct to 1 decimal place.

You must show **all** your working.

$x$	$x^3 - 3x$	
2	$2^3 - 3 \times 2 = 2$	Low
3	$3^3 - 3 \times 3 = 18$	High
2.5	$2.5^3 - 3 \times 2.5 = 8.125$	Low
2.6	$2.6^3 - 3 \times 2.6 = 9.776$	Low
2.7	$2.7^3 - 3 \times 2.7 = 11.583$	Low
2.8	$2.8^3 - 3 \times 2.8 = 13.552$	Low
2.9	$2.9^3 - 3 \times 2.9 = 15.689$	<u>High</u>
2.85	$2.85^3 - 3 \times 2.85 = 14.599$	<u>Low</u>

To 1 dp =  $x = 2.9$

$x = 2.9$

(Total for Question 8 is 4 marks)



9 Here is a solid prism.

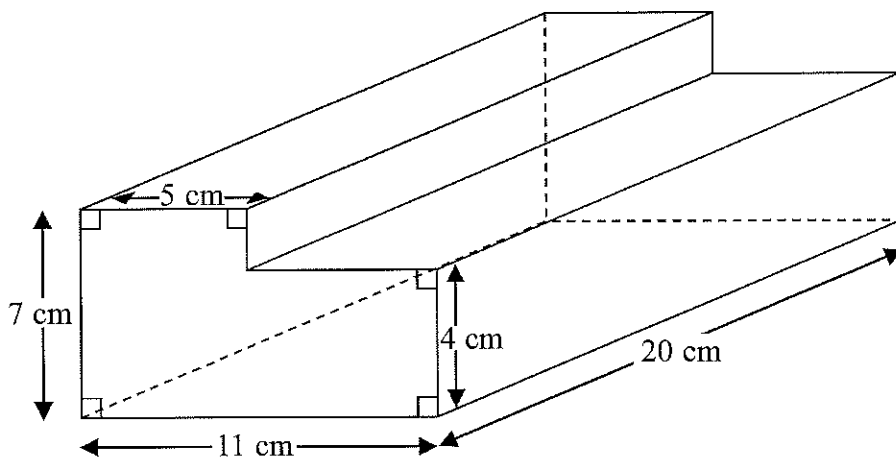
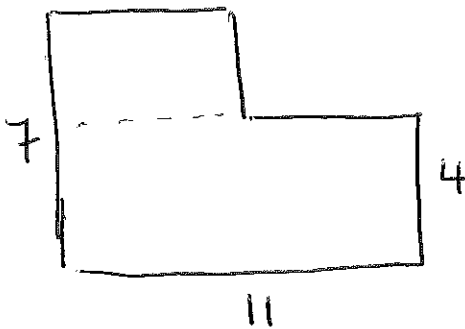

Diagram NOT accurately drawn

Work out the volume of the prism.

Volume = Area of cross-section  $\times$  length prism



$$\begin{aligned} \text{Area} &= (4 \times 11) + (3 \times 5) \\ &= 44 + 15 = 59 \text{ cm}^2 \end{aligned}$$

$$\text{Volume} = 59 \times 20 = 1180 \text{ cm}^3$$

1180 cm<sup>3</sup>

(Total for Question 9 is 3 marks)



10

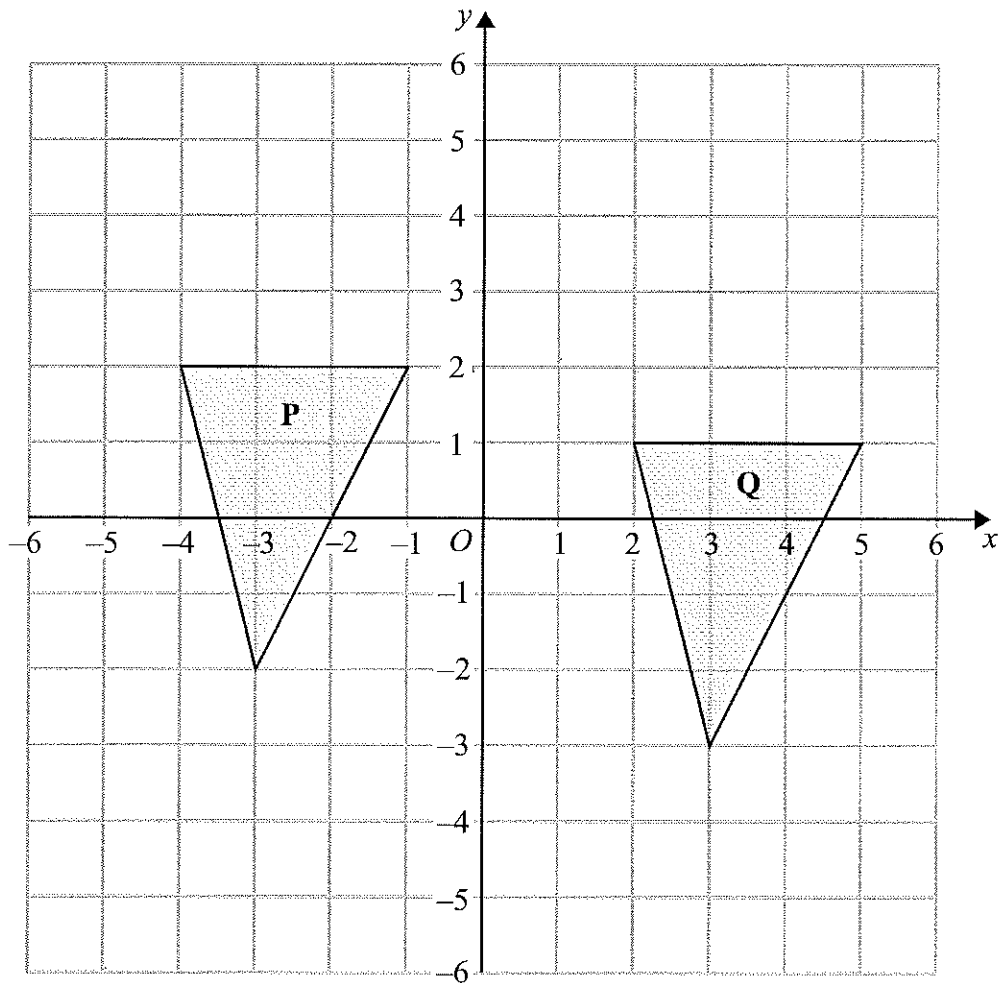

Describe fully the single transformation that maps triangle P onto triangle Q.

Translation (6 right, 1 down)

$$T \begin{pmatrix} +6 \\ -1 \end{pmatrix}$$

(Total for Question 10 is 2 marks)



11 (a) Expand and simplify  $3(x + 4) + 2(5x - 1)$

$$3x + 12 + 10x - 2$$
$$13x + 10$$

$$\frac{13x + 10}{(2)}$$

(b) Expand and simplify

$$(2x + 1)(x - 4)$$

$$2x^2 - 8x + x - 4$$
$$2x^2 - 7x - 4$$

$$\frac{2x^2 - 7x - 4}{(2)}$$

(c) Factorise completely

$$6y^2 - 9xy$$

$$2 \times 3 \times y \times y - 3 \times 3 \times x \times y$$
$$3y(2y - 3x)$$

$$\frac{3y(2y - 3x)}{(2)}$$

(Total for Question 11 is 6 marks)



12  $-3 < n \leq 1$

$n$  is an integer.

(a) Write down all the possible values of  $n$ .

$$n = -2; -1; 0; 1$$

$$\frac{-2; -1; 0; 1}{(2)}$$

(b) Solve the inequality  $3p - 7 > 11$

$$3p - 7 + 7 > 11 + 7$$

$$3p > 18$$

$$p > \frac{18}{3}$$

$$p > 6$$

$$\frac{p > 6}{(2)}$$

(Total for Question 12 is 4 marks)

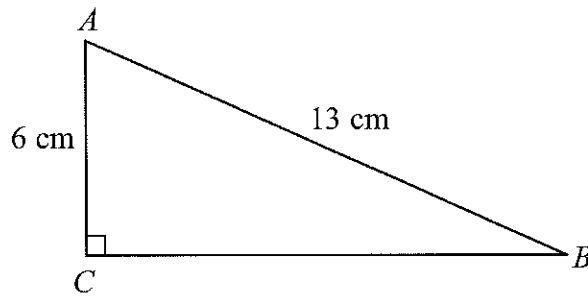

13

Diagram NOT  
accurately drawn $ABC$  is a right-angled triangle.

$AC = 6 \text{ cm}$

$AB = 13 \text{ cm}$

- (a) Work out the length of  $BC$ .  
Give your answer correct to 3 significant figures.

$$BC^2 + AC^2 = AB^2$$

$$BC^2 = 13^2 - 6^2$$

$$BC^2 = 133$$

$$BC = \sqrt{133}$$

$$\underline{\hspace{1cm} 11.5 \text{ cm} \hspace{1cm}}$$

(3)

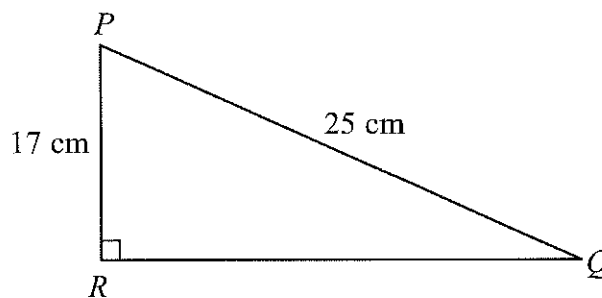
Diagram NOT  
accurately drawn $PQR$  is a right-angled triangle.

$PR = 17 \text{ cm}$

$PQ = 25 \text{ cm}$

- (b) Work out the size of angle  $RPQ$ .  
Give your answer correct to 1 decimal place.

$$\cos \hat{RPQ} = \frac{17}{25} = 0.68$$

$$\hat{RPQ} = \cos^{-1}(0.68)$$

$$\underline{\hspace{1cm} 47.2 \text{ }^\circ \hspace{1cm}}$$

(3)

(Total for Question 13 is 6 marks)



14  $A = 4bc$

$$A = 100$$

$$b = 2$$

(a) Work out the value of  $c$ .

$$4bc = A$$

$$c = \frac{A}{4b}$$

$$c = \frac{100}{4 \times 2} = \frac{100}{8}$$

$$\frac{12.5}{\dots\dots\dots}$$

(2)

$$m = \sqrt{\frac{k+1}{4}}$$

(b) Make  $k$  the subject of the formula.

$$m^2 = \frac{k+1}{4}$$

$$4m^2 = k+1$$

$$k = 4m^2 - 1$$

$$\frac{4m^2 - 1}{\dots\dots\dots}$$

(3)

(Total for Question 14 is 5 marks)



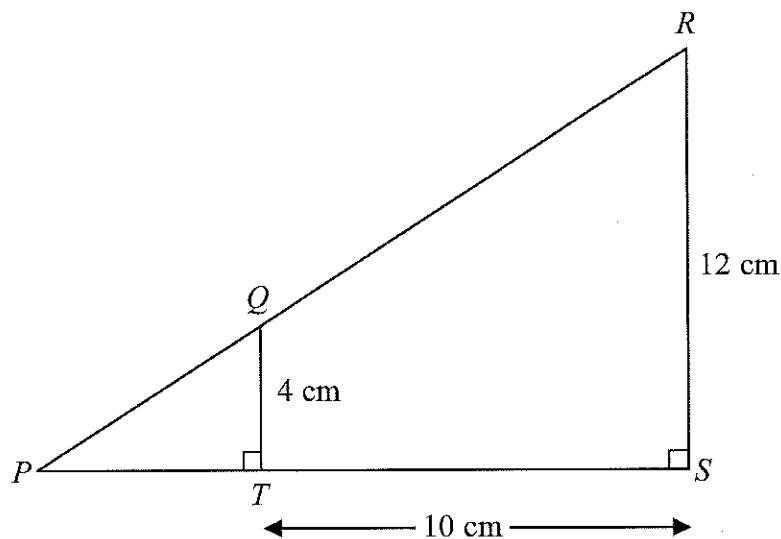

15

Diagram NOT  
accurately drawn $PQR$  and  $PTS$  are straight lines.Angle  $PTQ = \text{Angle } PSR = 90^\circ$  $QT = 4 \text{ cm}$  $RS = 12 \text{ cm}$  $TS = 10 \text{ cm}$ (a) Work out the area of the trapezium  $QRST$ .

$$A = \frac{12+4}{2} \times 10$$

$$\underline{\hspace{2cm} 80 \hspace{2cm}} \text{ cm}^2$$

(2)

(b) Work out the length of  $PT$ .
 $\Delta PQT$  similar to  $\Delta PRS$  ( $\hat{T} = \hat{S}$ ;  $\hat{Q} = \hat{R}$ ;  $\hat{P}$  common)

$$\frac{PT}{PS} = \frac{QT}{RS} \therefore \frac{PT}{PS} = \frac{4}{12} = \frac{1}{3}$$

$$\frac{PT}{PS} = \frac{1}{3} \therefore PT = \frac{1}{3} PS = \frac{1}{3} TS = \frac{1}{3} \times 10$$

$$\underline{\hspace{2cm} 5 \hspace{2cm}} \text{ cm}$$

(3)

(Total for Question 15 is 5 marks)



- 16 Derek buys a house for £150 000  
He sells the house for £154 500

(a) Work out Derek's percentage profit.

$$\begin{aligned} \% \text{ profit} &= \frac{154\,500 - 150\,000}{150\,000} = 0.03 \times 100 \\ &= 3\% \end{aligned}$$

..... 3 %  
(3)

Derek invests £154 500 for 2 years at 4% per year compound interest.

(b) Work out the value of the investment at the end of 2 years.

$$\text{End of yr1} = 154\,500 \times 1.04 = 160\,680$$

$$\begin{aligned} \text{End of yr2} &= 160\,680 \times 1.04 = 154\,500 \times 1.04 \times 1.04 \\ &= 154\,500 \times 1.04^2 = 167\,107.20 \end{aligned}$$

$$\left( 1.04 = 100\% + 4\% = 104\% = \frac{104}{100} = 1.04 \right)$$

£ 167107.20  
.....  
(3)

(Total for Question 16 is 6 marks)



17 Calculate the value of  $\sqrt{\frac{\tan 60^\circ + 1}{\tan 60^\circ - 1}}$

Write down all the figures on your calculator display.  
You must give your answer as a decimal.

1.931851653

(Total for Question 17 is 2 marks)



18 Here are the times, in seconds, that 15 people waited to be served at Rose's garden centre.

5 9 11 14 15 20 22 25 27 27 28 30 32 35 44

(a) On the grid, draw a box plot for this information. Median given by 8<sup>th</sup> value = 25

$$LQ = \frac{1}{4}(n+1) = \frac{1}{4}(15+1) = 4^{\text{th}} \text{ value} = 14$$

$$UQ = 4^{\text{th}} \times 3 = 12^{\text{th}} \text{ value} = 30$$

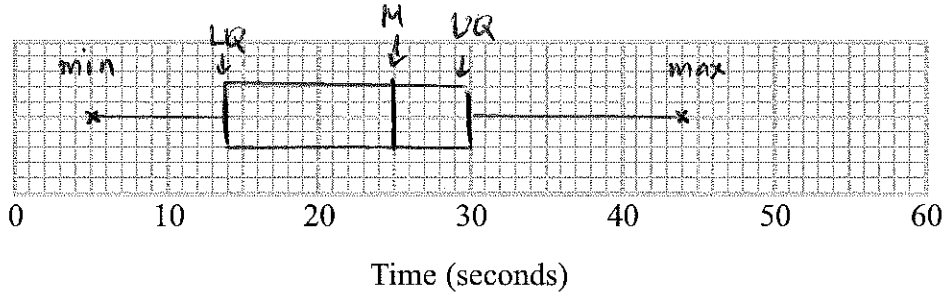

(3)

The box plot below shows the distribution of the times that people waited to be served at Green's garden centre.

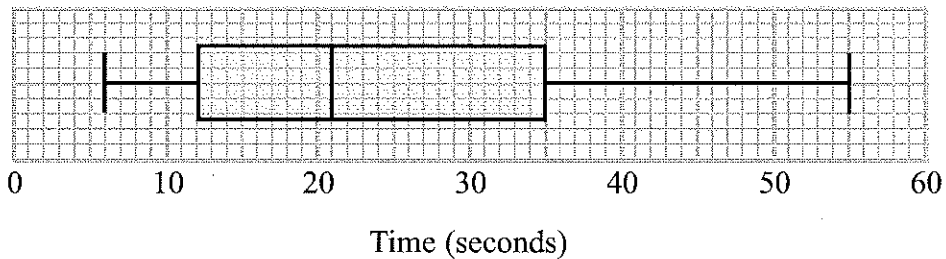

(b) Compare the distribution of the times that people waited at Rose's garden centre and the distribution of the times that people waited at Green's garden centre.

Median time (Rose garden) > Median time (Green)

IQR time (Rose garden) < IQR time (Green)

(2)

(Total for Question 18 is 5 marks)



19

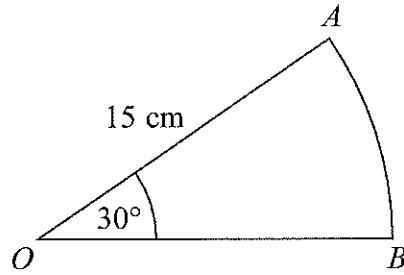

Diagram NOT  
accurately drawn

$OAB$  is a sector of a circle, centre  $O$ .  
The radius of the circle is 15 cm.  
The angle of the sector is  $30^\circ$ .

$$\text{Area} = \frac{\theta}{360} \times \pi r^2$$

Calculate the area of sector  $OAB$ .  
Give your answer correct to 3 significant figures.

$$\text{Area} = \frac{30}{360} \times \pi \times 15^2$$

=

58.9 cm<sup>2</sup>

(Total for Question 19 is 2 marks)



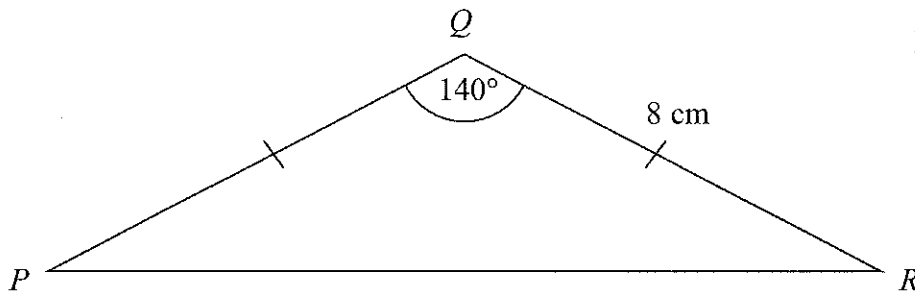

Diagram NOT  
accurately drawn

Calculate the length of  $PR$ .

Give your answer correct to 3 significant figures.

Using the cosine rule:

$$PR^2 = PQ^2 + RQ^2 - 2 PQ \times RQ \times \cos 140^\circ$$

$$PQ = RQ = 8 \text{ (isosceles } \Delta \text{)}$$

$$PR^2 = 2 PQ^2 - 2 PQ^2 \cos 140^\circ$$

$$PR = \sqrt{2 \times 8^2 - 2 \times 8^2 \times \cos 140^\circ}$$

$$PR = 15.0$$

..... 15.0 ..... cm

(Total for Question 20 is 3 marks)



21 The histogram shows some information about the weights of a sample of apples.

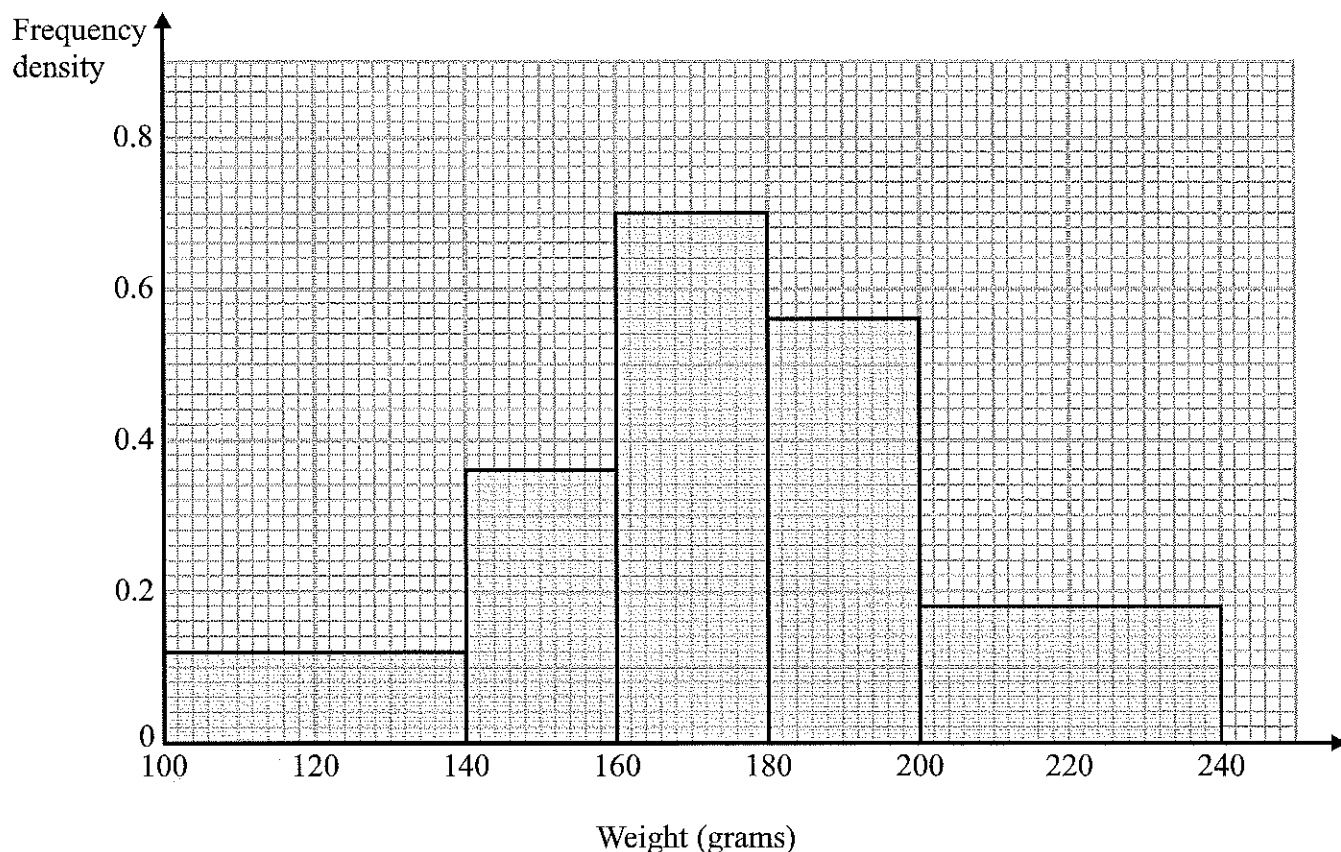

Work out the proportion of apples in the sample with a weight between 140 grams and 200 grams.

Number of apples between 140 - 200 :

$$20 \times 0.36 + 20 \times 0.7 + 20 \times 0.56 = 32.4$$

Total number of apples :

$$40 \times 0.12 + 32.4 + 40 \times 0.18 = 44.4$$

$$\text{proportion} = \frac{32.4}{44.4} = \frac{27}{37} \approx 0.73$$

$$\approx 73\%$$

0.73 or 73%

(Total for Question 21 is 4 marks)



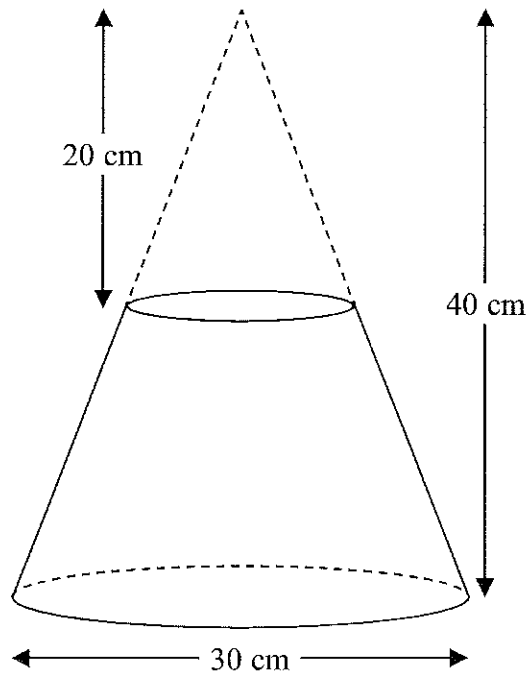

Diagram NOT  
accurately drawn

A frustum is made by removing a small cone from a similar large cone.

The height of the small cone is 20 cm.

The height of the large cone is 40 cm.

The diameter of the base of the large cone is 30 cm.

Work out the volume of the frustum.

Give your answer correct to 3 significant figures.

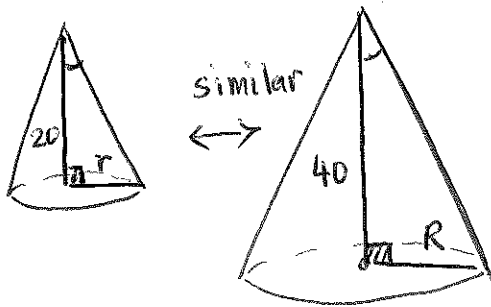

$$r = \frac{R}{2} = \frac{15}{2} = 7.5 \text{ cm} \quad \left( \begin{array}{l} 40 = 20 \times 2 \\ R = r \times 2 \end{array} \right)$$

$$\begin{aligned} V_F &= V_{BC} - V_{SC} = \frac{1}{3} \pi R^2 H - \frac{1}{3} \pi r^2 h \\ &= \frac{1}{3} \pi (R^2 H - r^2 h) \\ &= \frac{1}{3} \pi (15^2 \times 40 - 7.5^2 \times 20) \end{aligned}$$

BC = Big cone  
SC = Small cone  
F = Frustum

$$\underline{8250(3sf)} \text{ cm}^3$$

(Total for Question 22 is 4 marks)





23 The table shows information about the ages, in years, of 300 students.

Age (years)	11	12	13	14	15	16
Number of students	41	40	50	48	53	68

Ian takes a sample of 50 of these students, stratified by age.

Calculate the number of 16 year old students he should have in his sample.

Proportion of 16 year old is

$$\frac{68}{41 + 40 + 50 + 48 + 53 + 68} = \frac{68}{300}$$

In the sample:

Number of 16 year old is  $\frac{68}{300} \times 50$

11 students

(Total for Question 23 is 2 marks)



\*24  $m = \frac{\sqrt{s}}{t}$

$s = 3.47$  correct to 2 decimal places

$t = 8.132$  correct to 3 decimal places

By considering bounds, work out the value of  $m$  to a suitable degree of accuracy.

You must show all your working and give a reason for your final answer.

$$s = 3.47 \begin{cases} \rightarrow U_b = 3.475 \\ \rightarrow L_b = 3.465 \end{cases}$$

$$t = 8.132 \begin{cases} \rightarrow U_b = 8.1325 \\ \rightarrow L_b = 8.1315 \end{cases}$$

$$m_{Ub} = \frac{\sqrt{s_{Ub}}}{t_{Lb}} = \frac{\sqrt{3.475}}{8.1315} = 0.2292486$$

$$m_{Lb} = \frac{\sqrt{s_{Lb}}}{t_{Ub}} = \frac{\sqrt{3.465}}{8.1325} = 0.228890$$

$$m_{Ub} = m_{Lb} = 0.23 \text{ (2 dp)} \quad \text{or} \quad = 0.229 \text{ (3 dp)}$$

$$m = 0.23 \text{ (2 dp)} \quad = 0.229$$

(Total for Question 24 is 5 marks)



25 Here are two triangles  $T_1$  and  $T_2$ .

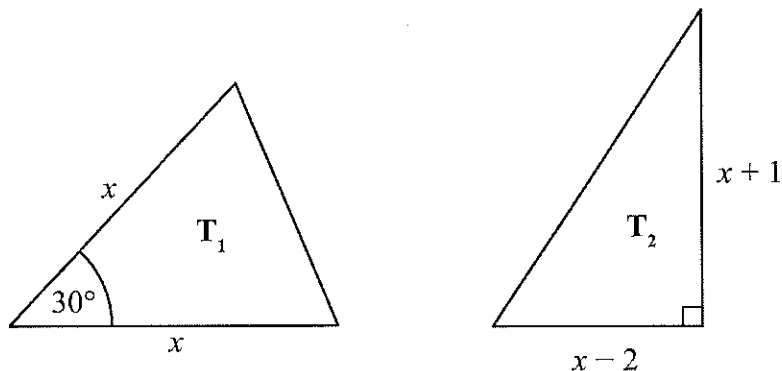

Diagram NOT accurately drawn

The lengths of the sides are in centimetres.

The area of triangle  $T_1$  is equal to the area of triangle  $T_2$ .

Work out the value of  $x$ , giving your answer in the form  $a + \sqrt{b}$  where  $a$  and  $b$  are integers.

$$\begin{aligned} \text{Area of } T_1 &= \frac{1}{2} \times x \times x \times \sin 30^\circ \\ &= \frac{1}{2} x^2 \times \frac{1}{2} = \frac{1}{4} x^2 \end{aligned}$$

$$\begin{aligned} \text{Area of } T_2 &= \frac{(x-2)(x+1)}{2} = \frac{x^2 + x - 2x - 2}{2} \\ &= \frac{x^2 - x - 2}{2} \end{aligned}$$

$$\text{Area of } T_1 = \text{Area of } T_2 \therefore \frac{1}{4} x^2 = \frac{x^2 - x - 2}{2}$$

$$\begin{aligned} \frac{1}{2} x^2 &= x^2 - x - 2 \\ x^2 &= 2x^2 - 2x - 4 \\ 2x^2 - 2x - 4 - x^2 &= 0 \\ x^2 - 2x - 4 &= 0 \end{aligned}$$

$$\begin{aligned} x &= \frac{2 \pm \sqrt{4 - 4(1)(-4)}}{2} \\ x &= \frac{2 \pm \sqrt{20}}{2} = \frac{2 \pm 2\sqrt{5}}{2} \\ x &= \frac{2 + 2\sqrt{5}}{2} \end{aligned}$$

$$x = 2 - 2\sqrt{5} < 0 \text{ invalid} \quad x = 2 + 2\sqrt{5}$$

(Total for Question 25 is 5 marks)

$$x = 1 + \sqrt{5}$$

TOTAL FOR PAPER IS 100 MARKS

**BLANK PAGE**

